

TARABUS

FLOORING FOR BUS & COACH INTERIORS



INSTALLATION GUIDELINES

Gerflor[®]
theflooringgroup

INTRODUCTION 4

STEP 1: PREPARATION & INSPECTION..... 5

1.1 Storage & Handling 5

1.2 Subfloor preparation 5

1.3 Floorcovering inspection 5

1.4 Adhesive selection 6

STEP 2: ROLL LAYOUT & CUTTING..... 6

2.1 Cutting to vehicle size 6

2.2 Pre-cut shipsets 6

STEP 3: ADHESIVES & INSTALLATION 7

3.1 Tarabus Self-Adhesive 7

3.2 Water-based acrylic adhesives 7

3.3 Neoprene/Contact adhesives 7

STEP 4: LOGOS & INSTALLATION 8

STEP 5: HOT WELDING PROCESS FOR FLAT, COVERED & VERTICAL AREAS..... 9

5.1 Treatment of seams using hot welding process 9

5.2 Hot welding tools 10

5.3 Hot welding process 10

STEP 6: CLEANING (refer to Tarabus Cleaning Guide)..... 12

ANNEX: TARABUS RECOMMENDED TOOL LIST 12

INTRODUCTION

Tarabus floorcoverings are designed to meet all global transportation industry requirements. To obtain optimum performance from Tarabus floorcoverings follow carefully our installation recommendations.

Important: failure to install Gerflor Transport products correctly will affect the product guarantee.

PRODUCT LIABILITY

Gerflor shall not be liable for any injury, loss or damage, whether direct, indirect, special, incident or consequential, arising out of the furnishing of, the use of, or any inability to use the Tarabus materials provided therefrom. The remedies of the purchaser set forth herein are exclusive, and the liability of Gerflor with respect to any sale or anything done in connection therewith, whether in contract, in tort, negligence, under any warranty or otherwise, shall not, except as expressly provided herein, exceed the cost of replacement of Tarabus materials upon which such liability is based. Buyers assume all risks and liability for damage to persons or property resulting from buyer's use of the material.

STEP 1: PREPARATION & INSPECTION

1.1 - STORAGE & HANDLING

- Tarabus flooring must be stored and installed at a temperature in between 15° and 30°Celsius.
- Tarabus flooring should not be exposed to water during transportation, storage, during and after installation. Thus, rolls should be stored in a protected environment (especially protected from rain and snow).
- Rolls (NT and MK backing) should be stored vertically, to reduce appearance of pressure marks. Rolls with NT backing can also be stored horizontally, individually on a foam insert.
- Rolls should be transported by use of a hand truck or with a fork lift.
- Relax the floorcovering by laying the pieces flat for 24 hours before installation



Storage



Handling

1.2 - SUBFLOOR PREPARATION

1.2.1 - Subfloor preparation

For all types of subfloors make sure surfaces are clean, smooth, flat, dry and free from contamination. Cleaning of the subfloor should be in accordance with the vehicle manufacturers Standard Operating Procedure.

All cleaning products used should be compatible with the surface being cleaned.



1.2.2 - Vehicle inspection

Before installation, carry out a vehicle inspection. Check the subfloor is properly fixed and flat according to the subfloor manufacturer recommendations.

1.2.3 - Timber subfloors

The subfloor panels should be securely fixed in place as per the specifications of individual vehicle manufacturers. All joints between panels should be sanded and filled to ensure a smooth transition.

1.2.4 - Metal subfloors

The subfloor panels should be securely fixed in place as per the specifications of individual vehicle manufacturers. Degrease and in case of corrosion abrade the metal floors. All joints between panels should be sanded and filled to ensure a smooth transition.

1.3 - FLOORCOVERING INSPECTION

- See Label Description.
- Check product, colour, and batch reference before installation. **Use the same batch throughout the vehicle.**
- For traceability purposes, the batch number should be kept.



INSTALLATION GUIDELINES

1.4 - ADHESIVE SELECTION

- Choosing the correct adhesive will ensure that the installed materials will perform as expected in service.
- You can find below recommended generic adhesives. For any adhesive not validated by Gerflor, it is the responsibility of the customer and adhesive manufacturer to ensure compatibility with subfloor and material.

RECOMMENDED ADHESIVE	APPLICATION	SUBSTRATES	FLEXIBILITY (grade from 1 to 5)	BOND STRENGTH (grade from 1 to 5)	DRYING TIME	REPOSITIONING
TARABUS SELF-ADHESIVE	Preapplied	All substrates	5	4	0 hour	Yes with care
WATER-BASED ACRYLIC	Subfloor only	Absorbant (not vertical)	5	4	12 hours	Yes up to 20/30 min.
NEOPRENE/CONTACT	Subfloor & Backing	All substrates	4	4	5-15 min (flash-off)	Yes with care

Gerflor will not accept responsibility for any occurrence where secondary additives or chemicals have been mixed with the primary adhesive. In such case, written confirmation from adhesive manufacturer should be provided.

STEP 2: ROLL LAYOUT & CUTTING

2.1 - CUTTING TO VEHICLE SIZE

Review the floor plan for the individual vehicle, establish the direction that the pieces will be installed in and define any weld position. Lay out the floorcovering on a clean, dry and flat working area. A template can be used to avoid cutting errors.

To optimize the installation process: Pre-cut and Pre-welded kits can be produced specifically to the individual requirements of the client. Please ask your sales representative for more information.

- Mark the lines to be cut-off or use a pattern as a template. Use a Delphin knife [E6000002] and a straight edge for cutting the material.
- Whether the material is to be installed flat or covered up the side of the vehicle Gerflor recommends that a minimum of 5 cm extra material is allowed on each end (10 cm overall) to ensure the piece is long enough and can be trimmed comfortably.
- When Joining Factory Edges – Leave a gap of 1 ± 0.5 mm maximum.
- Cut seams using any of the following methods:
 - Overlap and trace,
 - Underscribe (recess scribe method).

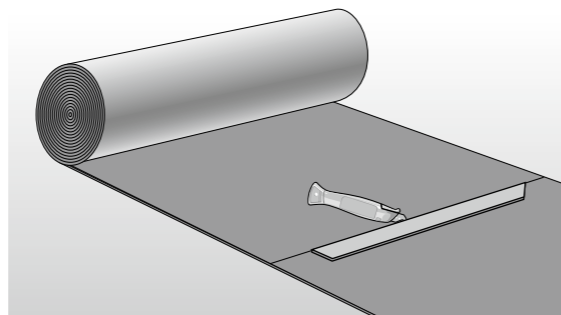

When installing designs of a geometric nature, it is important to ensure that the material is installed straight. Particular attention should be paid to release cuts on external corners when trimming the waste for positioning. Failure to not cut the material as close as possible to the base of the external angle may cause deformation of the design. This is due to excess material being forced around the base on the external corner. When making release cuts or removing excess waste, always cut the material from the backside.

2.2 - PRE-CUT SHIPSETS

Gerflor in-house cutting department is able to supply pre-cut pieces to specific dimensions from plans supplied by the customer.



INSTALLATION GUIDELINES

STEP 3: ADHESIVES & INSTALLATION

We propose 3 types of installation process depending on the adhesive solution.

3.1 - TARABUS SELF-ADHESIVE

- In case of rolls, cut the flooring to the area size.
- Lay out the floor into the car.
- Fold back one half.
- Use a hooked blade [E7520001] to cut the protective layer from the underside floor covering. Take care not to damage the floorcovering backing.



- Pull off the protective layer from the exposed half area.
- Position the material into the targeted location and make sure the air is expelled out towards the edges.
- Repeat steps 3 to 6 to the remaining half.
- The material can be welded immediately.



3.2 - WATER-BASED ACRYLIC ADHESIVES

Follow the adhesive manufacturer's instructions regarding subfloor types, correct trowel / blade size, open times, temperature and humidity conditions.

- Cut the flooring to the size required.
- Fold back the flooring halfway.
- Apply the adhesive to the subfloor. Use the recommended trowel and blade (Aluquick Spreader E6130001).
- Allow the adhesive to tack off (this will vary depending on temperature and subfloor absorbency).
- Place flooring into adhesive and smooth manually then use a pressure-roller.
- Repeat this process with the other half.
- Follow the manufacturer's guidelines for waiting times for welding and foot traffic.

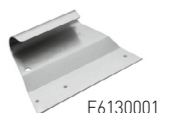

3.3 - NEOPRENE/CONTACT ADHESIVES

Follow the adhesive manufacturer's instructions regarding subfloor types, correct trowel / blade size, open times, temperature and humidity conditions.

- Cut the flooring to the size required.
- Lay out the flooring face down onto a flat working area.
- Apply adhesive to subfloor and to the back of the flooring. Adhesive can be applied by spray, trowel, or roller.
- Allow the adhesive to flash off and become touch dry.
- Position floor product on adhesive and roll thoroughly to ensure right contact with subfloor.
- The material can be repositioned with care.
- The material can be welded immediately.



With any adhesive system used to install the floorcovering, Gerflor always recommend the use of a cork press [E6640001] or cork broom [E6640002] to ensure a good initial contact and the expulsion of any air from beneath the product. On completion of the installation, the whole floor area should be rolled in the length and the width of the vehicle with a pressure-roller of 50 kg [E6320001].

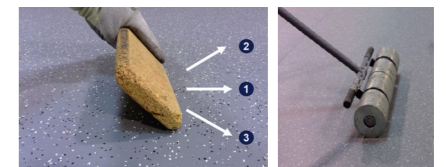

STEP 4: LOGOS & INSTALLATION

For complete watertightness, subfloor protection and high in-service performance Gerflor recommends the use of our laminate backed logos. It can be installed with self-adhesive backing or traditional glue.

TIP: Have a look at our Youtube video: [Tarabus Implantation Logo - YouTube](#)

Note: the logo on laminate backing should not be folded or rolled.



• Position and mark where the pre-cut logo will be located.



• Remove the protective layer of the self-adhesive logo or apply the traditional adhesive on subfloor.



• Once the logo is in place, press it with a cork press, install the floorcovering over the installed logo, and press it too, to optimize adhesion.
Recommended tools: Cork press (E6640001) or Cork broom (E6640002).



• Using a pressure roller, roll around the edge of the logo to identify its position.
Recommended tool: Internal angle roller (E6600001).



• Cut the waste from above the logo so that the main flooring material overlaps the logo by 5 cm max, leaving a 1 mm space all around.
Recommended tool: Delphin knife (E6000002).



• Using a recess scribe. Scribe around the logo while the pin in the scribe transfers and marks the surface of the main flooring material.
Recommended tool: Recess Scribe (E8220002).



• Carefully follow the scribed line with the knife. This will provide a clean line between logo and material.



• Use a Linea Groover to create the groove between logo and main material. You may use our Triangular Groover to refine the groove.
Recommended tools: Linea Groover (E8060001), Triangular Groover (E8000004).



• Hot weld the logo to the main flooring material using CR50.
Recommended tools: Welding Gun Leister Triac'S (E8090002), Anti-Glaze Rapid Nozzle 4-5mm (E8100002)

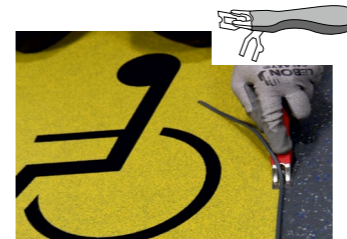

• Using the Mozart 2 in 1 Trimming Knife, with the 0.7 mm spacer, carry out the first trim of the weld cord. Do not carry out the second trim until the weld is completely cold.
Recommended tool: Mozart 2 in 1 Trimming Knife (E8300002).

• As final step, you may use a pressure-roller of 50 kg (E6320001) to optimize adhesion (rolling in the length and in the width).
• When installing self-adhesive flooring around a logo, before installing the flooring, cover the installed logo with a scrap piece of lining paper and secure at the perimeter with masking tape. This stops the self-adhesive layer sticking to the logo.

STEP 5: HOT WELDING PROCESS FOR FLAT, COVERED & VERTICAL AREAS

■ 5.1 - TREATMENT OF SEAMS USING HOT WELDING PROCESS

Hot Welding should only be completed after full cure of the adhesive. In case of self-adhesive, the welding can be completed right after the installation.

CR50 by Gerflor: Tarabus flat weld

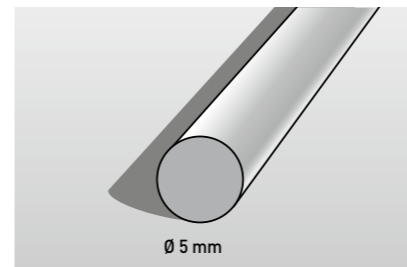



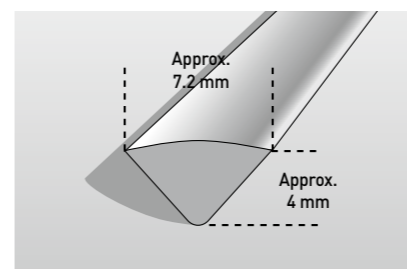

CA72 by Gerflor: Tarabus corner weld



INSTALLATION GUIDELINES

5.2 - HOT WELDING TOOLS

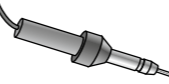
You can find below the recommended hot welding tools, divided into the 3 welding steps:

STEP	TOOL	PART NUMBER	
GROOVING	LINEA GROOVER	E8060001	
WELDING	ANTI-GLAZE RAPID NOZZLE 4-5 MM (flat weld)	E8100002	
	CA72 SPEED NOZZLE WITH WHEEL (corner weld)	E8100008	
	HOT WELDING GUN LEISTER TRIAC-S 220 V	E8090002	
TRIMMING	MOZART 2 IN 1 TRIMMING KNIFE	E8300002	

5.3 - HOT WELDING PROCESS

TIP: have a look at our YouTube video. [Hot Welding - Installation Guideline](#)

5.3.1 - Preparation

- Ensure that the gap between the adjoining sections of the flooring to be elded does not exceed 1 ± 0.5 mm.
- Seams must be grooved and clear of debris before welding.
- Ensure the nozzle is clear of debris.
- Turn on the gun adjusting the temperature dial to between 4.5 & 5 and leave to heat for 5 minutes before use.

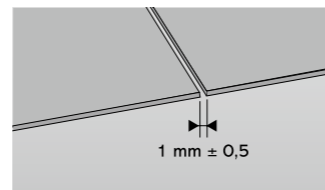

Tips: Test a weld on a small piece of waste flooring before starting welding in the vehicle. Weld rod should fuse without burning.

5.3.2 - Grooving

Various tools are available to produce a good quality and consistent groove. Gerflor recommends the Linea Groover (E8060001).

It's necessary to groove $2/3^{rd}$ s thickness of the wearlayer and to have a gap between the edges of 1 ± 0.5 mm. On the top, the gap after grooving is 3 ± 0.5 mm.



Linea Groover

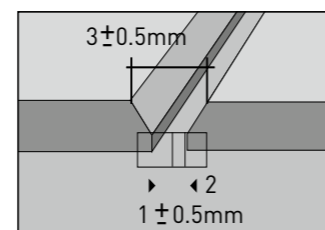

INSTALLATION GUIDELINES

5.3.3 - Welding

For flat welding, use a CR50 welding rod.

- Cut the colour matching weld cord to the required length.
- Hold the Hot Welding Gun Leister Triac-S (E8090002) at an upright angle and combine with constant pressure and speed as you progress along the weld. We recommend the use of our Anti-Glaze Rapid Nozzle 4-5 mm (E8100002).

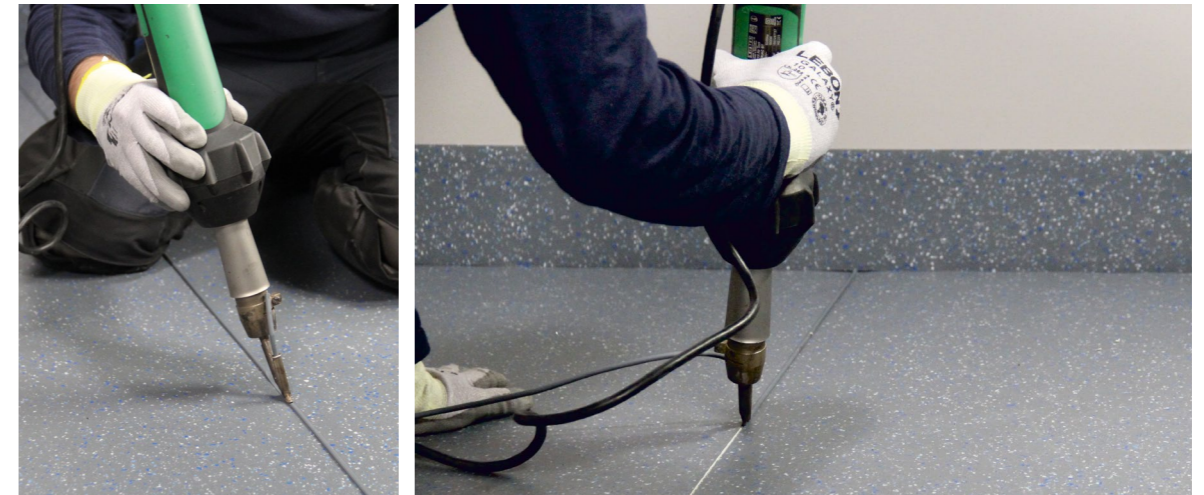

For corner weld, use a CA72 welding rod.

- Cut the colour matching weld cord to the required length.
- Hold the Hot Welding Gun Leister Triac-S (E8090002) with an angle that allows the rod to cover the base of the corner and combine with constant pressure and speed as you progress along the weld. We recommend the use of our Speed Nozzle with wheel (E8100008).



5.3.4 - Trimming

Trimming the weld cord should be completed in two stages.

- Trim the weld while still warm using the Mozart 2 in 1 trimming knife (E8300002) with the 0.7 mm spacer in place. This action will allow the weld cord to contract and relax. Retract the 0.7 mm spacer.
- Trim the remaining weld to produce a neat flush finish. **THIS PROCESS SHOULD ONLY BE COMPLETED WHEN THE WELD IS COMPLETELY COLD.**

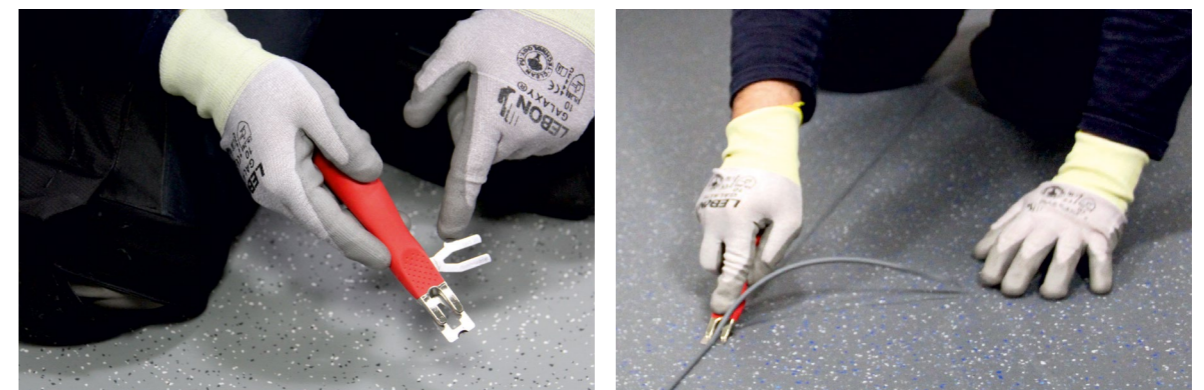











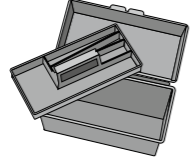

For finishes, move aside the trimming guide. Don't forget to regularly change the blade.

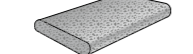
INSTALLATION GUIDELINES











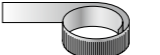





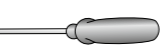



STEP 6: CLEANING (refer to Tarabus Cleaning Guide)

For further information, please contact your sales rep.
For technical advice please contact: andrew.sedman@gerflor.com (or loyde.cordero@gerflorusa.com for US).

ANNEX: TARABUS RECOMMENDED TOOL LIST

PART NUMBER	DESCRIPTION	GENERAL INSTALLATION	WELDING	LOGO	SELF-ADHESIVE
E8360001	LEISTER CARRYING CASE 				
E6000002	DELPHIN KNIFE (1 unit) 	✓	✓	✓	✓
E7510003	100 STRAIGHT BLADES 	✓	✓	✓	✓
E7520001	100 HOOKED BLADES 	✓	✓	✓	✓
E6600001	INTERNAL ANGLE ROLLER 	✓		✓	✓
E6640001	CORK PRESS with rounded edges 300 x 120 x 250 mm 	✓		✓	✓
E8000004	TRIANGULAR GROOVER 		✓	✓	
E8060001	LINEA GROOVER 		✓		
E8300002	MOZART 2 IN 1 TRIMMING KNIFE 		✓		
E8600001	WIRE BRUSH FOR NOZZLE DUCT 		✓		
E8100008	CA72 SPEED NOZZLE WITH WHEEL 		✓		
E8100002	ANTI-GLAZE RAPID NOZZLE 4-5 mm 		✓		
E8090002	HOT WELDING GUN LEISTER TRIAC-S 220 V 		✓	✓	

INSTALLATION GUIDELINES

OPTIONAL					
PART NUMBER	DESCRIPTION	GENERAL INSTALLATION	WELDING	LOGO	SELF-ADHESIVE
E3060001	CARPET CLAW 	✓			✓
E6150004	CONVEX RULER 210 x 8 cm FLEXIBLE STEEL 	✓	✓		✓
E6130001	ALUQUICK SPREADER 	✓		✓	
E6310001	SPARE BLADE A1 280 mm (10 units) 	✓		✓	
E6310003	SPARE BLADE A2 280 mm (10 units) 	✓		✓	
E8220002	RECESS SCRIBER 	✓		✓	✓
E6640002	CORK BROOM BALAI LIEGE 	✓		✓	✓
E6320001	PRESSURE-ROLLER (50 kg) 	✓		✓	✓
E8610001	BALL PRESSURE SHAFT Ø 13 mm 		✓		
E8100001	PUSH FIT NOZZLE HOLDER NOZZLE 4-5 mm 		✓		
E8110002	RAPID NOZZLE MUSHROOM SH. ROD 		✓		
E8100009	ROLLER TURBO NOZZLE 		✓		
E8000001	ROUNDED GROOVER 		✓	✓	
E8190001	SPARE BLADES (10 units) for Rounded Groover 		✓	✓	
E8320001	TRIMMING GUIDE 		✓		
E8040001	SPARE BLADES MOZART (5 units) 		✓	✓	
E8080001	TRIMMING GOUGE + 1 BLADE 		✓		
E8300003	QUARTER MOON TRIMMING KNIFE 		✓		
E8330001	LEATHER POUCH - 1/4 MOON KNIFE 		✓		
E8120001	2 ROUNDED BLADES 6 mm 		✓		
E8120003	2 FLAT BLADES 		✓		
E8120004	2 POINTED BLADES 		✓		



TARABUS

FLOORING FOR BUS & COACH INTERIORS

43, Boulevard Garibaldi
69170 Tarare - France
Tel.: +33 4 74 05 40 00
Fax: +33 4 74 05 06 83
Email: tarabus@gerflor.com
www.tarabusbygerflor.com



Gerflor[®]
theflooringgroup